

Butterfly valve BVHM and solenoid actuator MB 7

OPERATING INSTRUCTIONS

· Edition 05.24 · EN · 03251462



1 SAFETY

1.1 Please read and keep in a safe place



Please read through these instructions carefully before installing or operating. Following the installation, pass the instructions on to the operator. This unit must be installed and commissioned in accordance with the regulations and standards in force. These instructions can also be found at www.docuthek.com.

1.2 Explanation of symbols

1, 2, 3, a, b, c = Action

→ = Instruction

1.3 Liability

We will not be held liable for damage resulting from non-observance of the instructions and non-compliant use.

1.4 Safety instructions

Information that is relevant for safety is indicated in the instructions as follows:



DANGER

Indicates potentially fatal situations.



WARNING

Indicates possible danger to life and limb.



CAUTION

Indicates possible material damage.

All interventions may only be carried out by qualified gas technicians. Electrical interventions may only be carried out by qualified electricians.

1.5 Conversion, spare parts

All technical changes are prohibited. Only use OEM spare parts.

2 CHECKING THE USAGE

Butterfly valve BVHM with solenoid actuator MB 7 is used for cyclic operation on industrial burners for air and flue gas up to 450°C.

This function is only guaranteed when used within the specified limits – see page 5 (12 Technical data). Any other use is considered as non-compliant.

CONTENTS

1 Safety	1
2 Checking the usage	1
3 Installation	2
4 Wiring	3
5 Setting the flow rate	4
6 Setting the start gas rate	4
7 Replacing the damping unit	4
8 Replacing the solenoid actuator	4
9 Replacing the circuit board	4
10 Maintenance	4
11 Accessories	4
12 Technical data	5
13 Logistics	6
14 Certification	6
15 Disposal	6
16 Pressure units	6

2.1 Type code BVHM

BVHM	Butterfly valve for air and flue gas
40-100	Nominal size
T	T-product
Z	For fitting between two EN flanges
W	For fitting between two ANSI flanges
01	p_u max. 150 mbar
A	With stop

2.2 Type code MB 7

MB	Solenoid actuator
7	Actuator size 7 for DN 40-100
N	Quick opening, quick closing
R	Slow opening, slow closing
L	Slow opening, quick closing
W	Mains voltage 230 V AC, 50/60 Hz
Q	Mains voltage 120 V AC, 50/60 Hz
K	Mains voltage 24 V DC
3	Terminal connection box, IP 65
6	Connection box with 3-pin standard socket, IP 65

2.3 Part designations

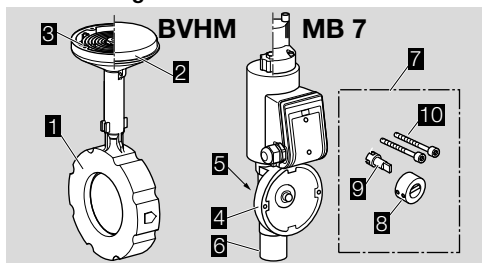

- 1 Solenoid actuator
- 2 BVHM
- 3 Cover
- 4 Seal
- 5 MB 7
- 6 Valve disc position indicator
- 7 Flow adjustment
- 8 Fastening set
- 9 Coupling ring
- 10 Coupling pin
- 11 2 x retaining screws

2.4 Type label

MB 7

Mains voltage, electrical power rating, inlet pressure, ambient temperature, enclosure and installation position: see type label.

BVHM

Inlet pressure, ambient temperature, medium and installation position: see type label.

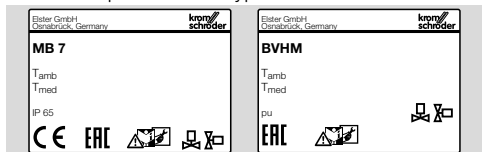

3 INSTALLATION

⚠ CAUTION

Incorrect installation

Please observe the following to ensure that the unit is not damaged during installation and operation:

- Avoid pressure surges and temperature shocks.
- Dropping the device can cause permanent damage. In this event, replace the entire device and associated modules before use.
- Sealing material and dirt, e.g. thread cuttings, must not be allowed to get into the unit.
- A filter must be installed upstream of every system.

- The butterfly valve is intended to be installed in-between two flanges.
- Install the unit in the pipe free of mechanical stress.
- The length of the inlet and outlet section should be $2 \times DN$.
- Installation position: black solenoid actuator in the vertical upright position or tilted up to the horizontal, not upside down.

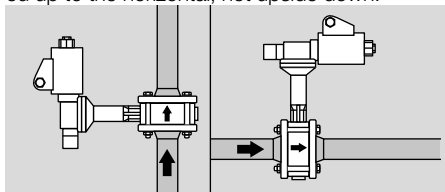

- Installation in the vertical position with the direction of flow from bottom to top prevents condensation and dirt from accumulating on the stop bar of the butterfly valve.

Hot air as a medium

- If you are using an insulated pipeline ensure that there is sufficient installation space to access the screw connectors near the valve.
- Do not insulate the butterfly valve or solenoid actuator with thermal insulation.
- Use heat deflectors for a medium temperature of $> 250^\circ\text{C}$, see accessories.
- Check the temperature resistance of the seals in the pipe!

Hot air as a medium

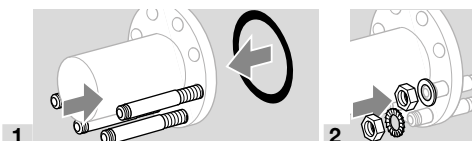

- Ensure that both serrated lock washers are fitted to the same screw.
- Install the butterfly valve in the pipe free of mechanical stress.
- Note the flow direction on the BVHM.

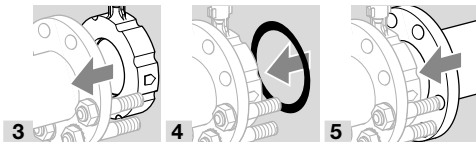

3 Centre the butterfly valve.

4 → The valve disc must open and close unobstructed.

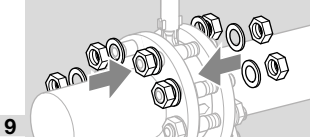
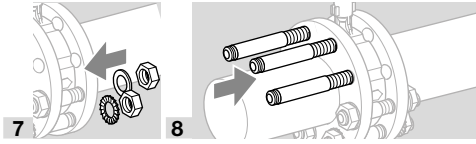

7 → Purge the pipes thoroughly after installation to remove any foreign particles from the system.

Mounting the MB 7 to the BVHM

→ The solenoid actuator may be installed on the butterfly valve rotated by 90°.

→ Install all parts from the fastening set.

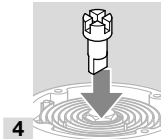
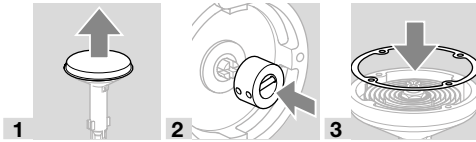

4 → The coupling pin must be flush.

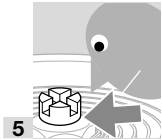

5 → The solenoid actuator with coupling ring is installed in the coupling pin of the butterfly valve at a slight angle (approx. 10°).

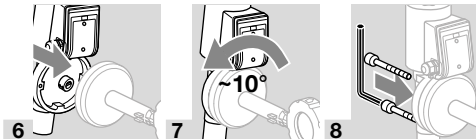

4 WIRING



WARNING

Risk of injury!

Please observe the following to ensure that no damage occurs:

- Electric shocks can be fatal! Before working on possible live components, ensure the unit is disconnected from the power supply.
- The solenoid actuator heats up during operation. Surface temperature approx. 85°C (approx. 185°F).



- Use temperature-resistant cable (> 90°C).
- Conductors which have not been connected (spare conductors) must be insulated at their ends.
- Cables should be installed well away from high-voltage lines of other devices.
- Use cables with wire end ferrules.
- Cable cross-section: max. 2.5 mm².
- 1** Disconnect the system from the electrical power supply.
- The butterfly valve is closed when de-energized.
- 2** Close the gas supply.
- Wiring to EN 60204-1.

MB 7..3 with cable gland

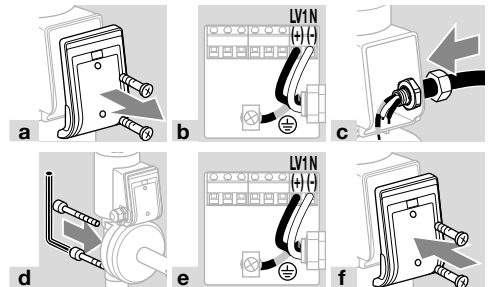

MB 7..6 with standard socket

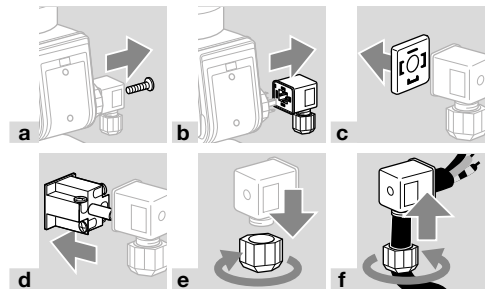

1 = N (-), 2 = LV1 (+)

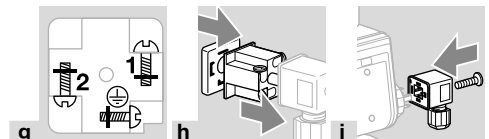

5 SETTING THE FLOW RATE

Valve disc position indicator

- If the marking is pointing in the direction of the black solenoid actuator, the butterfly valve is open (90°).

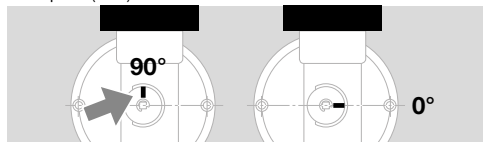

- Factory setting of flow rate Q :
 $Q_{\min.} = 0^\circ$, valve disc closed,
 $Q_{\max.} = 90^\circ$, valve disc fully open.
- The setting for $Q_{\min.}$ and $Q_{\max.}$ can be changed using two hexagonal nuts.

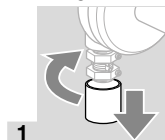

- In order to set $Q_{\max.}$, voltage must be applied to the solenoid actuator. The butterfly valve is closed when de-energized.

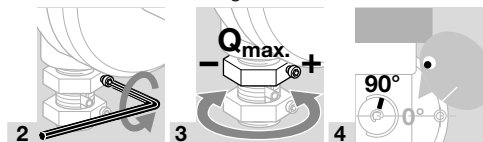

- In order to set $Q_{\min.}$, the solenoid actuator must be disconnected from the electrical power supply.

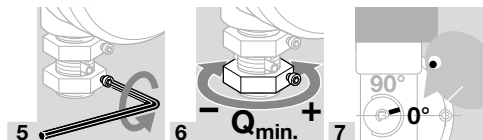

- 8 Once the settings have been adjusted successfully, retighten both screws to secure the adjusting nuts for $Q_{\min.}$ and $Q_{\max.}$.
- 9 Replace the cover on the flow adjustment unit.
- Instead of adjusting $Q_{\min.}$ via the hexagonal nut, the low-fire flow rate can also be set via an external bypass.

6 SETTING THE START GAS RATE

MB 7..L

- The start gas rate can be set by turning the damping unit a maximum of 3 turns.
- There must be a period of 20 seconds between switching the valve off and on again so that the damping is fully effective.
- Use a 3 mm Allen key.
- Undo the screw at the "V Start" mark by approx. 1 mm, but do not unscrew completely.

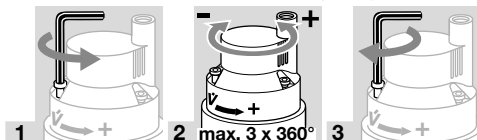

7 REPLACING THE DAMPING UNIT

See operating instructions enclosed with spare part or see www.docuthek.com.

A web app for selecting the correct spare part is available at www.adlatus.org.

8 REPLACING THE SOLENOID ACTUATOR

See operating instructions enclosed with spare part or see www.docuthek.com.

A web app for selecting the correct spare part is available at www.adlatus.org.

9 REPLACING THE CIRCUIT BOARD

See operating instructions enclosed with spare part or see www.docuthek.com.

A web app for selecting the correct spare part is available at www.adlatus.org.

10 MAINTENANCE

The butterfly valve suffers little wear and requires little servicing. We recommend a function check once a year.

11 ACCESSORIES

11.1 Fastening set for BVHM

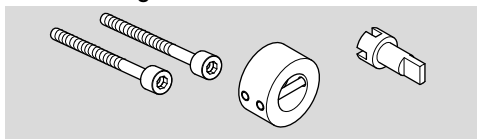

This is required to attach the solenoid actuator MB 7 to the butterfly valve BVHM. The fastening set is delivered enclosed as an additional item.

Order No.: 74922222

11.2 Heat deflectors

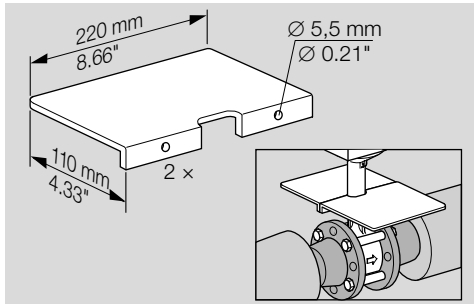

In conjunction with the butterfly valve BVHM, the solenoid actuator can be used for hot air of: up to 250°C (480°F), up to 450°C (840°F) when heat deflectors are installed.

If you are using an insulated pipeline ensure that there is sufficient installation space to access the heat deflectors and the screw connectors near the valve.

Order No.: 74921670

12 TECHNICAL DATA

12.1 Ambient conditions

Icing, condensation and dew in and on the unit are not permitted.

Avoid direct sunlight or radiation from red-hot surfaces on the unit. Note the maximum medium and ambient temperatures!

Avoid corrosive influences, e.g. salty ambient air or SO₂.

The unit may only be stored/installed in enclosed rooms/buildings.

The unit is suitable for a maximum installation height of 2000 m AMSL.

Ambient temperature:

BVHM: -20 to +60°C (-4 to +140°F).

MB 7: -20 to +60°C (-4 to +140°F).

Long-term use in the upper ambient temperature range accelerates the ageing of the elastomer materials and reduces the service life (please contact manufacturer).

MB 7: Enclosure: IP 65.

This unit is not suitable for cleaning with a high-pressure cleaner and/or cleaning products.

12.2 Mechanical data for BVHM

Gas type: air and flue gas.

The gas must be clean and dry in all temperature conditions and must not contain condensate.

Medium temperature: -20 to +450°C (-4 to +840°F).

Nominal size: DN 40 to 100.

Housing material: GGG,

valve disc: stainless steel,

drive shaft: stainless steel.

Inlet pressure p₁: max. 150 mbar (2.18 psig).

Pressure differential between inlet pressure p₁ and outlet pressure p₂: max. 150 mbar (2.18 psig).

12.3 Electrical data for MB 7

Mains voltage:

230 V AC, +10/-15%, 50/60 Hz,

120 V AC, +10/-15%, 50/60 Hz,

24 V DC, +20/-20%.

Voltage	Power
230 V AC	100 W
120 V AC	108 W
24 V DC	85 W

Current consumption:

Current I = power consumption [VA] / voltage [V]

Enclosure: IP 65.

This unit is not suitable for cleaning with a high-pressure cleaner and/or cleaning products.

MB 7R

Slow opening: approx. 2 to 4 s

Slow closing: approx. 2 to 4 s

MB 7N

Quick opening: < 1 s

Quick closing: < 1 s

MB 7L

Slow opening: approx. 2 to 4 s

Quick closing: < 1 s

Number of operating cycles

The solenoid actuators have been designed for a typical number of operating cycles as described below, pursuant to Elster internal design and construction specifications.

These values are purely for information purposes and are not intended by Elster to be legally binding. Elster cannot accept liability for the durability or condition of the product beyond the scope described in the Standards.

The information given refers to an ambient temperature of +20°C (+68°F).

Type	Switching operations	Δp
MB 7 + BVHM 40	5,000,000	150 mbar (2.18 psi)
MB 7 + BVHM 50	4,000,000	130 mbar (1.88 psi)
MB 7 + BVHM 65	3,000,000	95 mbar (1.38 psi)
MB 7 + BVHM 80	2,000,000	55 mbar (0.80 psi)
MB 7 + BVHM 100	1,000,000	20 mbar (0.29 psi)

13 LOGISTICS

Transport

Protect the unit from external forces (blows, shocks, vibration).

Transport temperature: see page 5 (12 Technical data).

Transport is subject to the ambient conditions described.

Report any transport damage on the unit or packaging without delay.

Check that the delivery is complete.

Storage

Storage temperature: see page 5 (12 Technical data).

Storage is subject to the ambient conditions described.

Storage time: 6 months in the original packaging before using for the first time. If stored for longer than this, the overall service life will be reduced by the corresponding amount of extra storage time.

14 CERTIFICATION

14.1 Declaration of conformity



We, the manufacturer, hereby declare that the products MB 7 comply with the requirements of the listed Directives and Standards.

Directives:

- 2014/35/EU – LVD
- 2014/30/EU – EMC
- 2011/65/EU – RoHS II
- 2015/863/EU – RoHS III

Standards:

- EN 13611:2016-09

Elster GmbH

Scan of the Declaration of conformity (D, GB) – see www.docuthek.com

14.2 ANSI/CSA approved



Canadian Standards Association – ANSI/UL 429 and CSA C22.2 No. 139-13

14.3 REACH Regulation

The device contains substances of very high concern which are listed in the Candidate List of the European REACH Regulation No. 1907/2006. See Reach list HTS at www.docuthek.com.

14.4 China RoHS

Directive on the restriction of the use of hazardous substances (RoHS) in China. Scan of the Disclosure Table China RoHS2, see certificates at www.docuthek.com.

15 DISPOSAL

Devices with electronic components:

WEEE Directive 2012/19/EU – Waste Electrical and Electronic Equipment Directive



At the end of the product life (number of operating cycles reached), dispose of the packaging and product in a corresponding recycling centre. Do not dispose of the unit with the usual domestic refuse. Do not burn the product.

On request, old units may be returned carriage paid to the manufacturer in accordance with the relevant waste legislation requirements.

16 PRESSURE UNITS

mbar	Pa	kPa	"WC
1	100	0.1	0.4

FOR MORE INFORMATION

The Honeywell Thermal Solutions family of products includes Honeywell Combustion Safety, Eclipse, Exothermics, Hauck, Kromschroder and Maxon. To learn more about our products, visit ThermalSolutions.honeywell.com or contact your Honeywell Sales Engineer.

Elster GmbH
Strotheweg 1, D-49504 Lotte
T +49 541 1214-0
hts.lotte@honeywell.com
www.kromschroeder.com

Global centralized service deployment coordination:
T +49 541 1214-365 or -555
hts.service.germany@honeywell.com

Translation from the German
© 2024 Elster GmbH

Honeywell
kromschroder